

**evo**  
HOME LIFTS

# Product Catalogue

**BEST VALUE 4000 & PREMIUM 6000**

BEST VALUE 4000  
Gallery

Get  
Quote

PREMIUM 6000  
Gallery

  
**ARITCO**<sup>TM</sup>  
Home lifts





## Welcome to next level living

Our vision is to make home lifts a natural part of homeowners' lives. A home lift means so much more than just moving from one floor to another.

The journey started 20 years ago, with the simple idea of improving mobility everywhere. Today, you will find Aritco lifts in more than 30,000 buildings and private homes around the world.

We constantly seek new ways to improve, both when it comes to

the product, environmental impact and quality, as well as the design and user friendliness. Safety and reliability is a top priority following Europe's highest quality and safety standards.

All Aritco lifts are developed and produced in Kungsängen, Sweden, and we are proud to maintain the highest quality in every detail, from design to installation in your home.

Lifts with you in mind

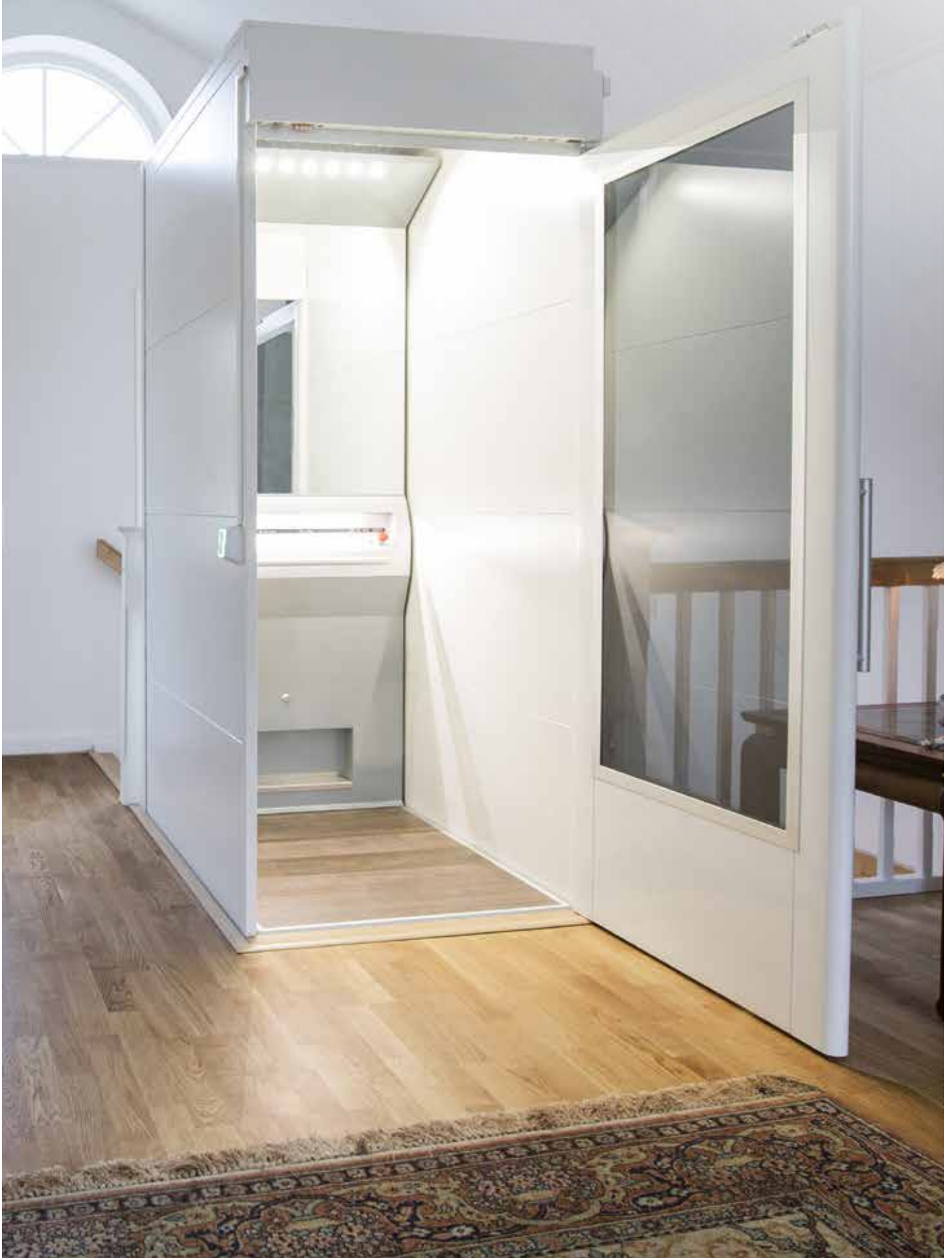



We have designed our home lifts with your home in mind. All Aritco home lifts have been designed with both safety and

reliability in focus: to meet all kinds of situations that can occur in a home.

# Much smarter than conventional lifts.

To understand just how brilliant our home lifts really are you need to know a little about conventional lifts. A conventional lift requires machinery above and a deep pit beneath the lift. It requires a pre-built shaft and the installation may take several weeks. Such operations cost a lot of money, demands space and could mean that the lift ends up in a part of the house which is far from comfort and convenience.

Our home lifts use a well-tested and reliable screw and nut drive

system, developed and adapted to the requirements of a home environment. All machinery fits inside the lift walls. This means our lifts do not need any space for neither pit nor machinery; they can be placed directly on the floor practically anywhere. Since our home lifts do not have a traditional cabin we have maximised the internal space and minimised the external dimensions. And the installation is so much simpler and quicker. The complete lift is installed in just a couple of days.











## Increase the value of you home.

By having a home that is safe and accessible for everyone, you facilitate many moments of happiness. Being able to open your home to all the ones you love adds extra meaning to life and everyone will feel welcome.

Additionally it increases the actual value and attraction of your home, just like a swimming pool, garage or a new kitchen would do.



## Models that meet your needs.

Our classic models of home lifts come in two different models Aritco 4000 and Aritco 6000. The major difference between them is the size.

Aritco 4000 is the smallest, most compact home lift on the market. It is designed to meet every requirement for comfort, space and style. It's available in three different sizes.

Aritco 6000 is our larger sized home lift with great possibilities to choose different appearances and styles. You can choose between six different sizes, materials, types of glass and colours.

Both Aritco 4000 and 6000 allow you to make your personal choices of lift colour, floor coverings, glass types and door types.



**Aritco 4000**

**Platform width**.....580-1080 mm  
**Platform length**.....805 mm



**Aritco 6000**

**Platform width**.....900-1100 mm  
**Platform length**.....1040-1480 mm





A modern, white lift with a glass door is shown in a library setting. The lift is partially open, revealing a bookshelf and a piano in the background. The floor is highly reflective, showing the lift and the surrounding environment. The text "Build your own interactive home lift." is overlaid at the top of the image.

Build your own interactive home lift.

We have designed a couple of smart and innovative tools to help you imagine a lift in your own home. Design your lift with different materials and options in our tool LiftGuide at [aritcohomelifts.com/4000-6000](http://aritcohomelifts.com/4000-6000).

Or download and try our inspiring applications from Google Play or App Store by simply searching for Aritco.



# Aritco 4000

## LIFT COLOUR

Can be painted in any RAL colour from the RAL Classic chart.

## FLOOR

9 different floorings to choose from.



## GLASS

4 different glass types to choose from.



## DOORS

2 different door types to choose from.

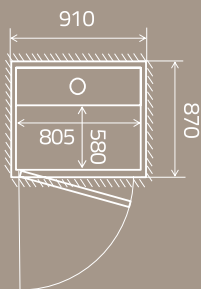
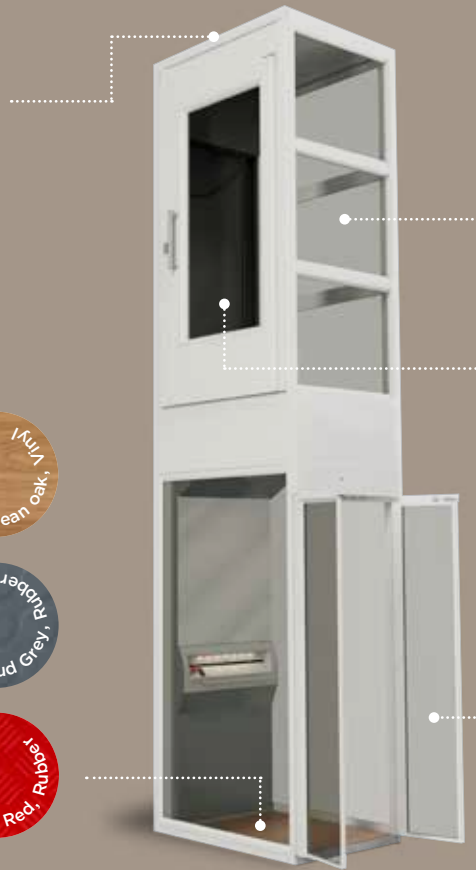

**Size: 580 x 805 mm**  
Rated load: 250 kg / 2 persons

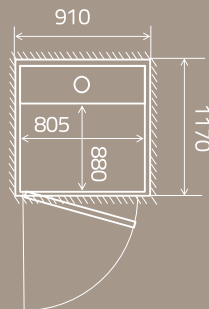

**Size: 880 x 805 mm**  
Rated load: 250 kg / 2 persons

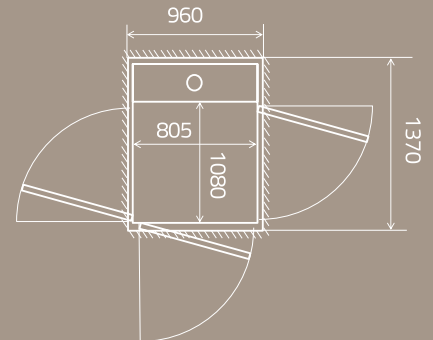

**Size: 1080 x 805 mm**  
Rated load: 250 kg / 2 persons

## Product summary

<p><b>TOP HEIGHT</b></p> <p><b>2300 mm</b></p>	<p><b>TYPE OF LIFT</b></p> <p>Home lift intended for installation in private homes.</p>	 <p><b>RATED SPEED</b></p> <p>Max <b>0,15 m/s</b></p>	 <p><b>DRIVE SYSTEM</b></p> <p>Patented screw and nut system 1.5 kW motor</p>	<p><b>CONTROL FROM CARRIER CONTROL PANEL</b></p> <p><b>Hold to run</b> - press and hold <b>For installations outside Europe</b> - One touch operation (press one time)</p>	<p><b>NUMBER OF FLOORS</b></p>  <p>2 to 6 floors</p>
<p><b>INSTALLATION</b></p> <p><b>Recessed installation</b> 50 mm below floor</p> <p><b>Installed directly on floor</b> with 50 mm ramp</p>	<p><b>INDOOR</b> INSTALLATION ENVIRONMENT</p>	<p><b>TRAVEL HEIGHT</b></p> <p><b>250–13 000 millimeter</b></p>	<p><b>WARRANTY</b></p> <p>Aritco 4000 comes with a 24 month warranty. The screw and nut assembly has a 10 year warranty.</p>	<p><b>TECHNICAL COMPLIANCE</b></p> <p>European Machine directive 2006/42/EC European standard EN 81-41</p>	
<p><b>Control voltage</b></p> <p>24 V</p>			<p><i>Emergency lowering: Battery-powered</i></p>		

# Aritco 6000

**FLOOR**  
9 different floorings to choose from.



**LIFT COLOUR**  
Can be painted in any RAL colour from the RAL Classic chart.

**GLASS**  
4 different glass types to choose from.



**DOORS**  
2 different door types to choose from.

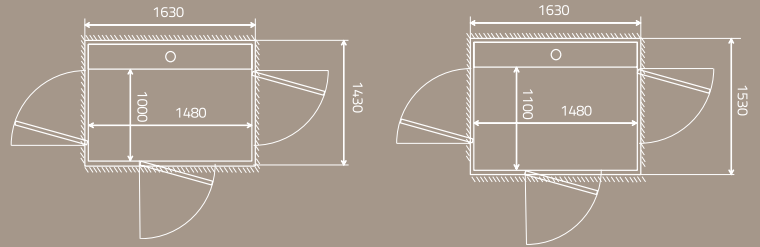

**Size: 1000 x 1480 mm**  
Rated load:  
410 kg / 5 persons

**Size: 1100 x 1480 mm**  
Rated load:  
410 kg / 5 persons

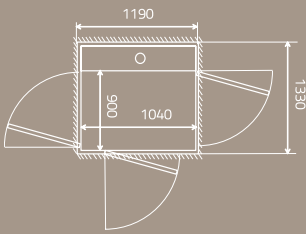

**Size: 900 x 1040 mm**  
Rated load:  
250 kg / 2 persons

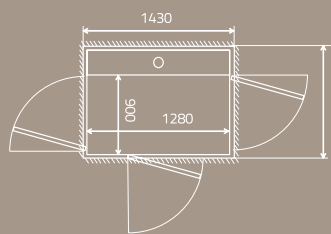

**Size: 900 x 1280 mm**  
Rated load:  
410 kg / 5 persons

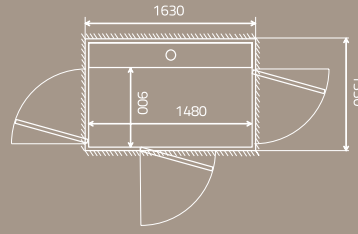

**Size: 900 x 1480 mm**  
Rated load:  
410 kg / 5 persons

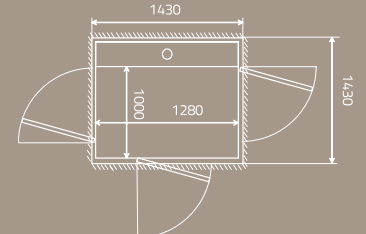

**Size: 1000 x 1280 mm**  
Rated load:  
410 kg / 5 persons

## Product summary

**TOP HEIGHT**  
**Minimum 2240 mm**



### INSTALLATION

**Recessed installation**  
50 mm below floor

**Installed directly on floor** with 50 mm ramp

**Control voltage**  
24 V

**TYPE OF LIFT**  
Home lift intended for installation in private homes.

**INDOOR**  
INSTALLATION ENVIRONMENT



### RATED SPEED

Max **0,15 m/s** inside Europe  
Max **0,25 m/s** outside Europe



### DRIVE SYSTEM

Patented screw and nut system  
2.2 kW motor

### CONTROL FROM CARRIER CONTROL PANEL

**Hold to run** - press and hold  
**For installations outside Europe**  
- One touch operation (press one time)

### NUMBER OF FLOORS

**2 to 6 floors**



### WARRANTY

Aritco 6000 comes with a 24 month warranty. The screw and nut assembly has a 10 year warranty.



### TECHNICAL COMPLIANCE

European Machine directive 2006/42/EC  
European standard EN 81-41

### TRAVEL HEIGHT

**250-13 000 millimeter**

*Emergency lowering:* Battery-powered



**eVO**HomeLifts Ltd  
International House  
Southampton International Business Park  
George Curl Way, Southampton  
SO18 2RZ

**t.** 020 3195 3958  
**e.** [sales@evohomelifts.co.uk](mailto:sales@evohomelifts.co.uk)  
[www.evohomelifts.co.uk](http://www.evohomelifts.co.uk)

BEST VALUE 4000  
Gallery

Get  
Quote

PREMIUM 6000  
Gallery

